

# OLYMPUS

Culture Microscope

## CKX53

CKX3 Series

**ДИА•М**  
современная лаборатория

[www.dia-m.ru](http://www.dia-m.ru)  
заказ on-line

The Cell Culture Laboratory Solution





# Improved Imaging and Usability

## Ease Cell Cultivation

With improved image quality and easy handling, the Olympus CKX53 microscope delivers stable performance and efficiency for a variety of cell culture needs, including live cell observation, cell sampling and handling, image capture, and fluorescence observation.

### Live Cell Observation

Acquire clear, reproducible, and high-contrast images with a wide visual field, made possible by the microscope's long-life LED and iPC system. Additionally, the inversion contrast (IVC) technique provides clear three-dimensional views.

### Cell Sampling and Handling

Because of its small size and lightweight design, the CKX53 microscope enables easier, more efficient cell sampling and handling in a clean bench environment. The user-friendly design and easy-to-operate holder and manual stage maximize performance and usability.

### Image Capture

Equipped with a standardized camera port, the microscope can be optionally paired with an Olympus camera, allowing users to quickly obtain clear images in brightfield illumination, phase contrast, inversion contrast, and fluorescence imaging modes.

### Fluorescence Observation

During fluorescence observation, a wide range of fluorescence dyes can be used by changing the microscope's mirror unit. With the mirror unit's increased filtering ability, high-contrast fluorescence images with a high S/N ratio can be reliably obtained even when fluorescence is relatively weak. In addition, the microscope's LED and LDP light source enables clear, bright fluorescence observation.



# Live Cell Observations

## Fast and Efficient Cell Observation with the Integrated Phase Contrast (iPC) System

The CKX53 iPC system's high contrast provides clear images without having to change the ring slit from a 4x to 40x objective. This simplifies your cell observation and makes your process more efficient.

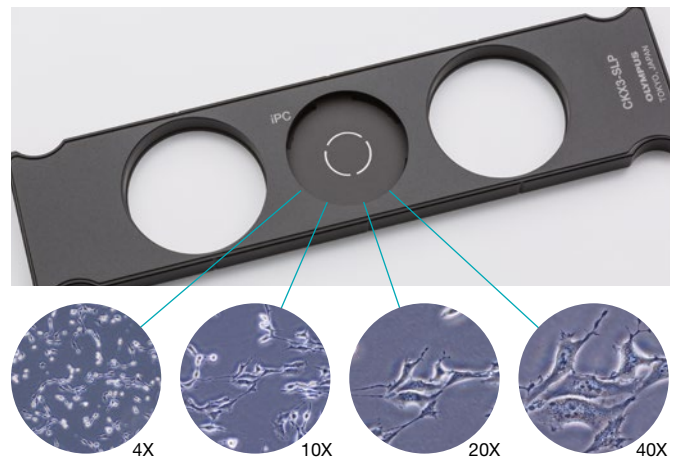

## Clear View with Long-Life LED Light Illumination

With a much longer life than halogen bulbs, the microscope's energy-saving LED light source delivers reliable color reproducibility as well as a uniform, clear image over the entire visual field up to FN22.

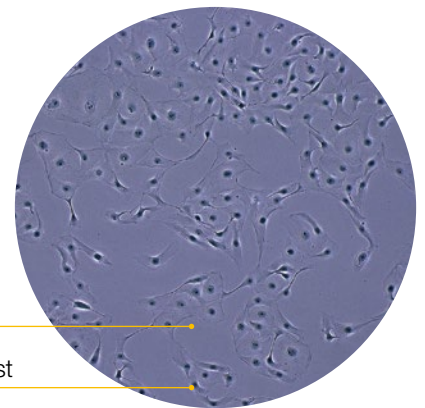

Clear view over the whole visual field

Phase contrast observation with high contrast



## Wide and Clear View with a 2X Objective

The ring slit for the PLN2X objective—CKX3-SLPAS—has a 22 mm field of view and an 11 mm diameter. This enables you to efficiently screen cells for a faster cell culture process. In addition, the 2x objective provides higher contrast so that transparent objects in the sample can be easily identified.

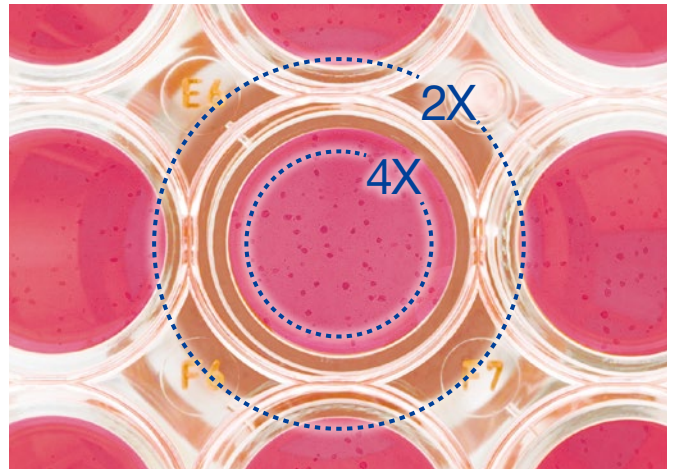

When viewing a 96-well plate, the wide visual field allows all the cells in a well to be observed without moving the stage.

## 3D Views using the Inversion Contrast (IVC) Technique

The IVC technique uses a narrower depth of field than phase contrast, enabling you to obtain clear three-dimensional images for objects of any shape, including transparent ones. IVC provides clear views without halos or directional shadows, preserving the integrity of object details during observation.

\*10X objectives (PLCN10X, CACHN10XIPC) are lined up for IVC observation.

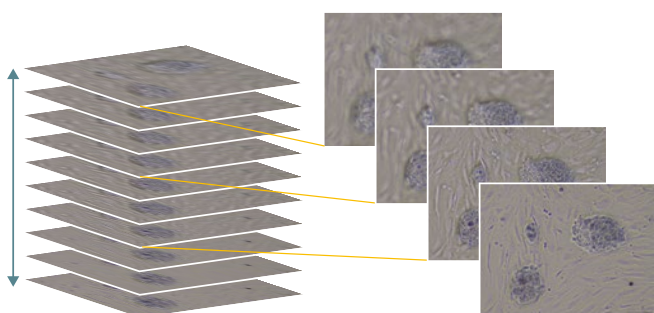
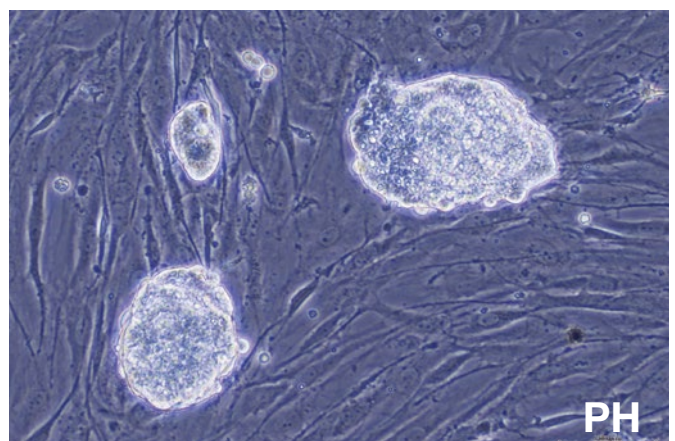
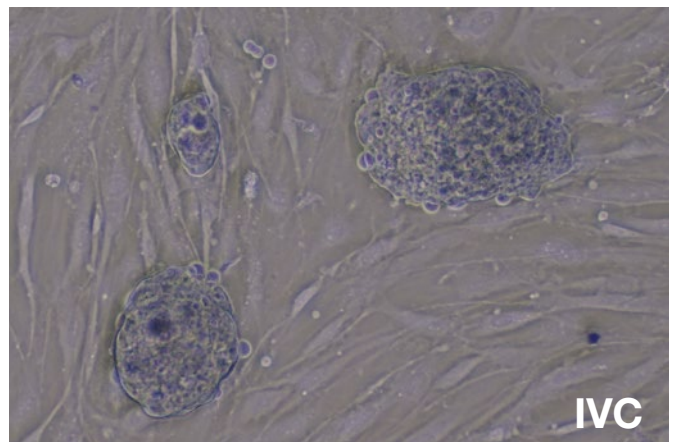

Reference: Y. Suzuki et al., Method for observing phase objects without halos or directional shadows. Opt Lett. 2015; 40(5): 812-5

# User-Oriented Design for Efficient Cell Sampling and Handling

## Easy Cell Observations in Sterile Conditions

The CKX53 microscope easily fits in a clean bench environment with the hood down, enables cells to be handled in sterile conditions. With a UV-resistant coating, the microscope can be left on the clean bench during UV light sterilization. The CKX53 microscope weighs only 7 kg (15.4 lb) and has a smaller footprint than previous models. It's designed to be lifted by the neck of the observation tube using one hand and has a convenient sliding pad on its base.

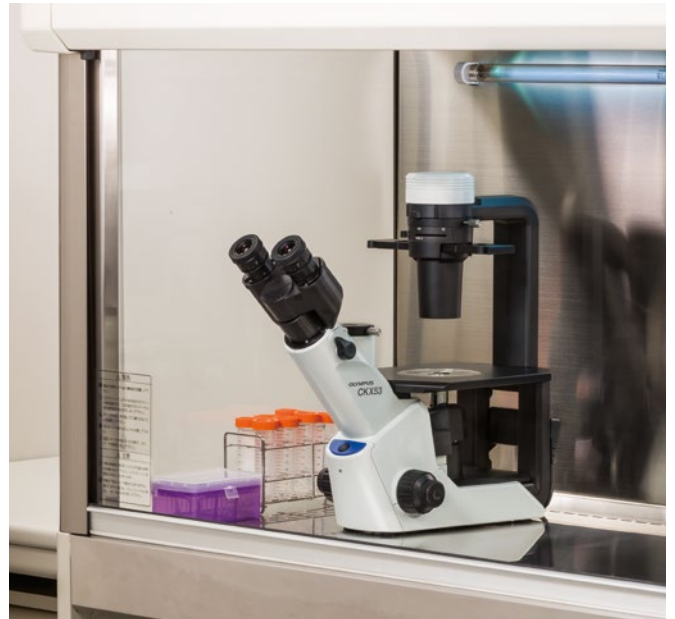

## Easy Cell Sampling in a Clean Bench Environment

The shorter distance between the view point and the optical axis/focus knob offers natural hand positioning and makes focusing and cell sampling easier.

In addition, the LED light is available as soon as you turn the microscope on, so cell sampling and handling can be finished more quickly.



## Ergonomic for Easy and Smooth Operation

Whether standing or seated, the 45-degree optical access and placement of the butterfly-shaped observation tube against the stage enables ergonomic cell observation. Sterile work can be started and finished quickly, so cells can be returned to the incubator in a minimal amount of time.

The power switch is located under the observation tube close to the knob for switching the light path for greater ease of use.



## Accommodates a Variety of Cell Culture Containers

Using the universal holder, you can easily view cells that were cultured in a variety of containers, including dishes, microplates, and flasks. When the optional holder is attached, up to three 35 mm dishes can fit on the stage.

Microplates can be viewed without a holder, and you can quickly identify the well address using the grid showing each well position on the CKX3-MVR manual stage. When viewing a 96-well plate, each 90-degree rotation of the stage knob moves the well one position at a time, making it easy to keep track of the microplate position during observation.



## More Comprehensive Observation for a Multi-Layer Tissue Flask

Detach the condenser to view containers—such as multi-layer tissue flasks—up to 190 mm tall. The objectives can be lifted up to 19 mm, enabling you to observe cells on the bottom two layers of a multi-layer tissue flask when using a PLCN4X objective.



## Flexible to Use Different Containers

The holder's arms can be lifted to manually position the culture container. The stage can be extended up to 70 mm (2.8 in.) to the left and right for greater handling flexibility.

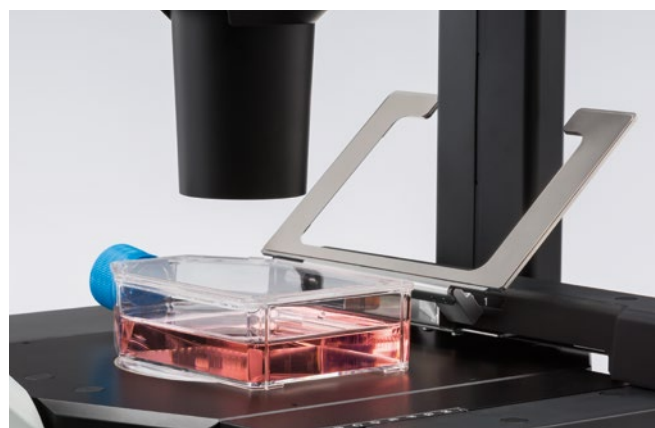

# Fluorescence Observation

## Clear Views with a Wide Range of Fluorescence Dyes

With the CKX53 standard fluorescence set, even weak fluorescence signals can be viewed clearly using the integrated LED and LDP light source (U-LGPS). The same high-performance mirror unit found on IX3 and BX3 microscopes can be set at three slots of the mirror unit slider. You can obtain the same high-quality fluorescence observation as high-end inverted microscopes for a range of fluorescence dyes. Compared to previous models, the improved filtering ability of the fluorescence mirror units produces images with higher contrast.

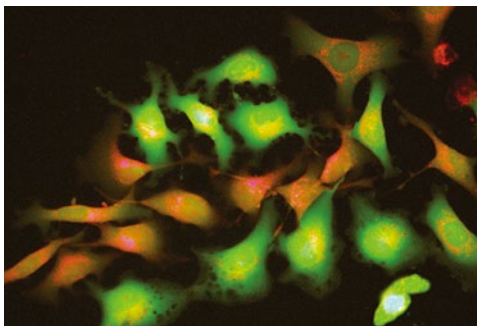

## High Contrast under Bright Conditions

The microscope's umbra shield improves fluorescence observation by efficiently blocking out room light, enhancing the contrast and enabling clear fluorescence observation in bright conditions. When using phase contrast, you can lift the umbra shield so that light will pass through the sample.

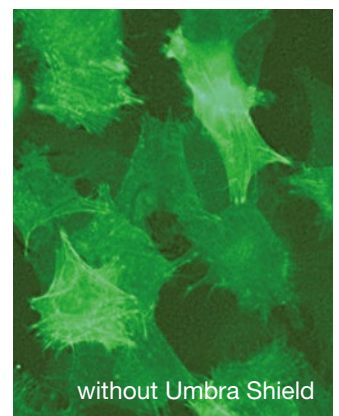
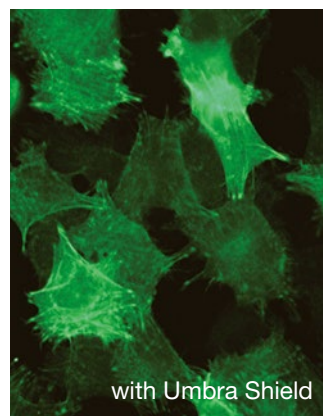



# Olympus Cell Culture Solutions

## Quickly Capture Clear Images

The CKX53 microscope has a standard camera port. When paired with a DP23 camera, the software's cell culture mode captures the appropriate color for cell culture samples, enabling the microscope to quickly capture high-quality images. For even more versatility, any camera with a C-type lens mount can be used with the microscope.



## Streamline Your Cell Culture Workflow with the Cell Counter Model R1

Pair your CKX53 microscope with the model R1 for fast live imaging and accurate cell counting. This combination enables a more efficient cell observation and counting workflow.

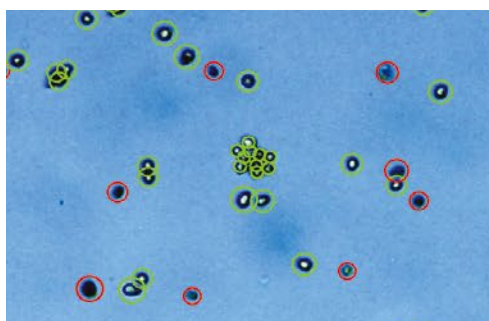

○ :Live cells    ○ :Dead cells



DP23 and Cell Counter model R1 are for research use only.

# CKX53 Configurations

## Four Upgradeable Base Configurations

### Brightfield

This package features brightfield objectives (4X and 10X) and is used for observing stained samples e.g., protoplasts, other plant parts, plankton, and similar specimens.



### Phase Contrast Entry

This package features phase contrast objectives (4X, 10X, and 20X) and is used for observing the condition and activity of transparent live cells.



### Phase Contrast Standard

This package features phase contrast objectives (4X, 10X, 20X, and 40X) and the manual stage (CKX3-MVR). It is useful not only for observing the condition and activity of transparent live cells, but also for observing detailed structures within the cells.



### Fluorescence

This package features an LED and LDP light source (U-LGPS) and fluorescent illuminator, as well as phase contrast objectives (4X, 10X, 20X, and 40X) and the manual stage (CKX3-MVR).



# CKX53 System Diagram

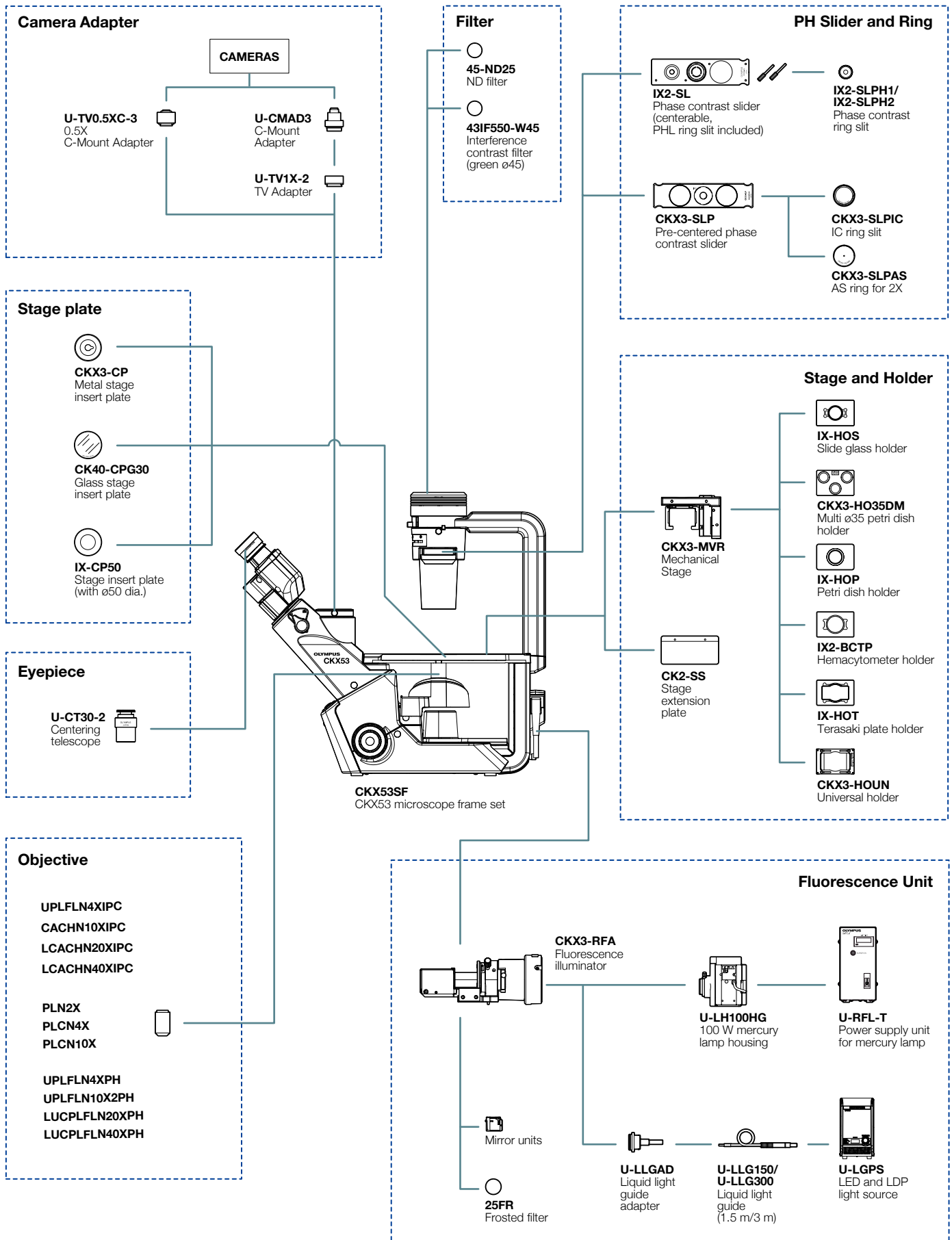

## SPECIFICATIONS

Item	CKX53			
Model	Brightfield	Phase Contrast Entry	Phase Contrast Standard	Fluorescence
Optical system	UIS2 (universal infinity-corrected) optical system			
Focus	Revolving nosepiece vertical movement system using the coarse and fine focusing knobs. Stroke: 20 mm (Focal point: up to 18.5 mm from the plain stage top surface) Stroke per rotation : 36.8 mm (coarse), 0.3 mm (fine)			
Stage	Plain stage (D × W)	252 mm × 200 mm (9.9 in. × 7.9 in.) Exchangeable transparent insert plate is incorporated		
	Mechanical stage	Options	XY coaxial knob place on right side of the plain stage Microplate holder equipped with the escape function stage stroke: X = 110 mm, Y = 74 mm	
	Substage (D × W)	180 mm × 70 mm (7 in. × 2.8 in.)		
Illumination system	Light source	4000K color temperature LED light source		
	Filter holder	Insert up to 6 mm thick with ø45 mm filter, detachable		
	Aperture diaphragm	Diaphragm blade, manual open/close system		
	Slider insertion	Options	With phase slider pocket and built-in slider position click stop mechanism pre-centered iPC aperture in 4X, 10X, 20X, and 40X; insertion direction can be adjusted ±30 degrees to the right or left sides	
iPC slider	Options	Pre-centered phase contrast aperture for 4X, 10X, 20X, and 40X and 2 ø45 mm empty apertures		
Condenser	Maximum numerical aperture: 0.3 Working distance: 72 mm Applicable objective magnification 2X, 4X, 10X, 20X, and 40X up to 190 mm height tissue flask can be loaded on the stage without detachable condenser			
Observation tube	Fixed trinocular tube, inclined 45 degrees Interpupillary distance 48–75 mm Light path: eyepiece/camera port = 100/0 ⇔ 0/100			
Camera port	Olympus camera adaptor interface			
Eyepiece	Magnification: 10X FN 22			
Fluorescence illuminator	FL light source	Options	Detachable illuminator 3-channel switchable	
	FL light shutter		LED/LDP light source, or 100 W mercury	
	FL field stop		Available	
	FL mirror units		Available	
	Umbra shield		2 mirror units (B & G) and UIS2 mirror unit (optional)	
Rated voltage/ electric current	AC 100-240V 50/60 Hz 0.4A		AC 100-240V 50/60Hz 0.4A AC 100-240V 50/60Hz 1.6A	
Power consumption	Less than 4 W		154 W	

## UIS2 OBJECTIVES

Objective	NA	W.D.	Remarks
PLN2X	0.06	5.8	
PLCN4X	0.1	18.5	
PLCN10X	0.25	10.6	
UPLFLN4XIPC	0.13	16.4	For use with CKX3-SLP
CACHN10XIPC	0.25	8.8	For use with CKX3-SLP
LCACHN20XIPC	0.4	3.2	For use with CKX3-SLP
LCACHN40XIPC	0.55	2.2	For use with CKX3-SLP
UPLFLN4XPH	0.13	16.4	PHL (For use with IX2-SL)
UPLFLN10X2PH	0.3	10	PH1 (For use with IX2-SL)
LUCPLFLN20XPH	0.45	6.6-7.8	PH1 (For use with IX2-SL)
LUCPLFLN40XPH	0.6	3-4.2	PH2 (For use with IX2-SL)

## DIMENSIONS

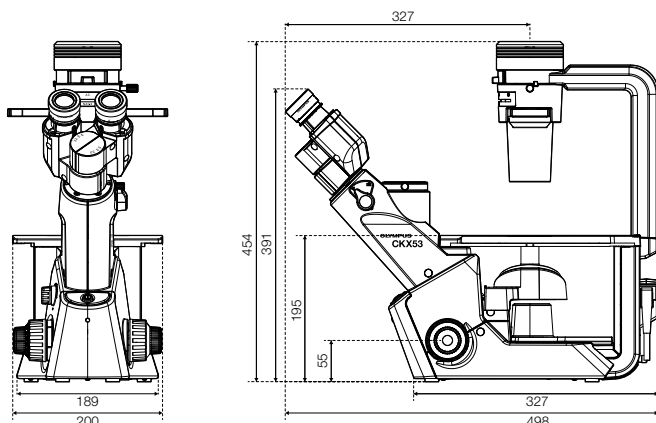

(Unit:

**000 «Диаэм»**

Москва

ул. Магаданская, д. 7, к. 3 ■ тел./факс: (495) 745-0508 ■ sales@dia-m.ru

[www.dia-m.ru](http://www.dia-m.ru)

**Новосибирск**  
пр. Академика  
Лаврентьева, д. 6/1  
тел.  
(383) 328-0048  
nsk@dia-m.ru

**Казань**  
ул. Парижской  
Коммуны, д. 6  
тел.  
(843) 210-2080  
kazan@dia-m.ru

**С.-Петербург**  
ул. Профессора  
Попова, д. 23  
тел.  
(812) 372-6040  
spb@dia-m.ru

**Ростов-на-Дону**  
пер. Семашко, д. 114  
тел.  
(863) 303-5500  
rnd@dia-m.ru

**Пермь**  
Представитель  
тел.  
(342) 202-2239  
perm@dia-m.ru

**Воронеж**  
Представитель  
тел.  
(473) 232-4412  
voronezh@dia-m.ru

**Армения**  
Представитель  
тел.  
(094) 01-0173  
armenia@dia-m.ru

**Узбекистан**  
Представитель  
тел.  
(90) 354-8569  
uz@dia-m.ru

- OLYMPUS CORPORATION is ISO14001 certified.
- OLYMPUS CORPORATION is ISO9001 certified.
- OLYMPUS CORPORATION is ISO13485 certified.
- Illumination devices for microscope have suggested lifetimes.  
Periodic inspections are required. Please visit our website for details.

- All company and product names are registered trademarks and/or trademarks of their respective owners.
- Images on the PC monitors are simulated.
- Specifications and appearances are subject to change without any notice or obligation on the part of the manufacturer.

[www.olympus-lifescience.com](http://www.olympus-lifescience.com)

**OLYMPUS**

OLYMPUS CORPORATION

Shinjuku Monolith, 2-3-1 Nishi-Shinjuku, Shinjuku-ku, Tokyo 163-0914, Japan

N8600216-042021