

IceCube™

Cryoconservation using
dynamic freezing processes

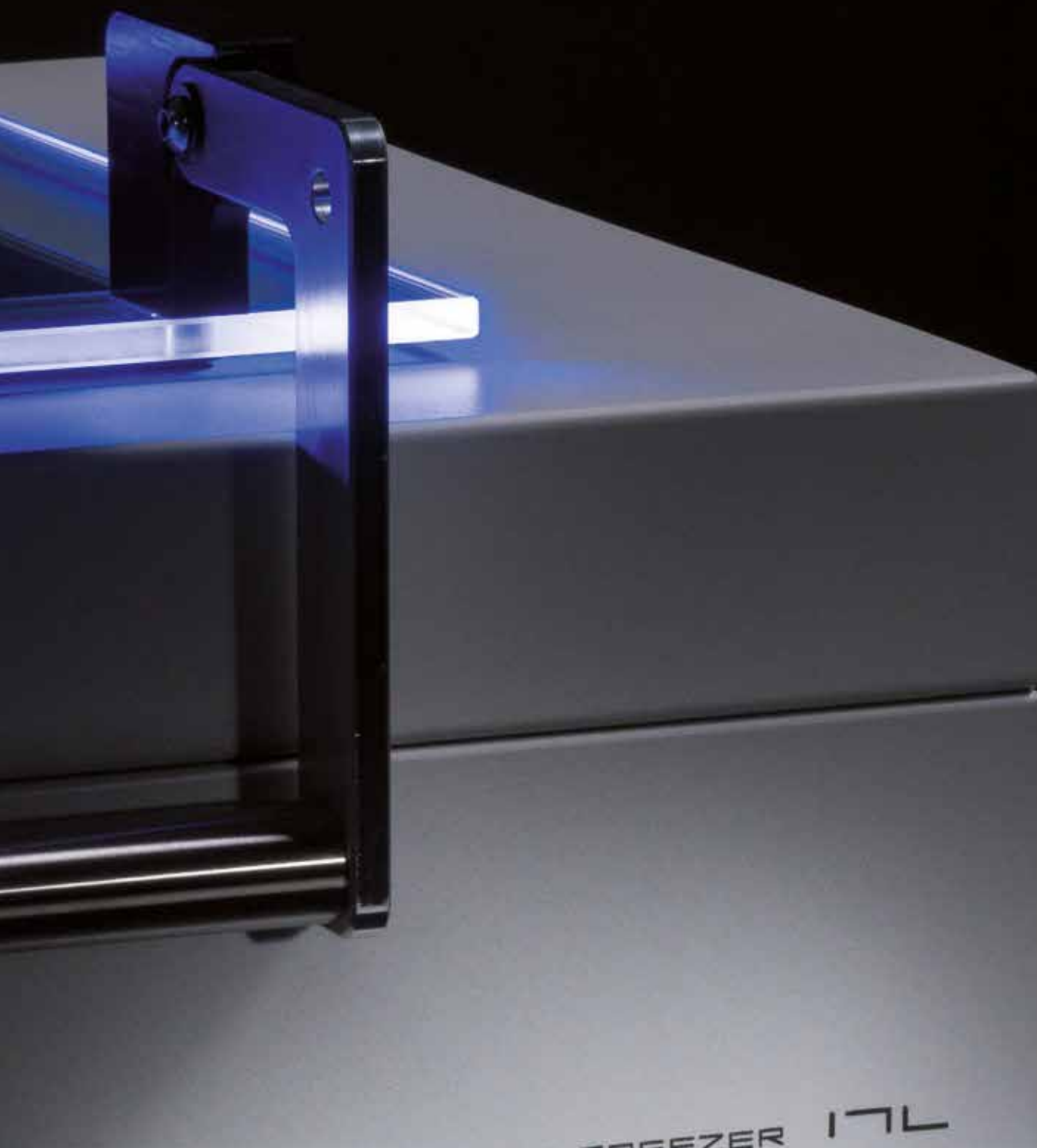

IceCube™ COMPUTER CONTROLLED FREEZERS

for freezing and thawing of biologic material

Controlled rate freezing is an established procedure for the cryopreservation of biologic material in research and clinical applications. In-line with GMP protocols, cell material can be frozen then stored at cryogenic temperatures.

IceCube devices achieve reliable, reproducible results with maximum operational safety. They are used for clinical, veterinary and research tasks for controlled rate freezing and thawing of samples. Medical Device Directive (MDD) certification is available.

The intuitive, flexible IceCube Series is designed specifically to meet current and future challenges of cryopreservation.

Easy to use software – with simple “recipe” control produces reliable and robust results. Our combination of efficient technology and intuitive operations has made us one of the world’s leading producers of controlled rate programmable freezers.



CRYODATA The IceCube™-Success

DOUBLE COMPUTER SUPPORT

While an internal microprocessor controls the defined process flow, an external PC or tablet provides a simple user interface and control monitor for data input and output.

Operating parameters can be easily adjusted to perform daily routine tasks through to highly complex scientific experiments. The graphical interface allows for straight-forward review and simple editing of your freezing profiles.

Most models include automatic program creation wizards.

Some Basic Functions (Series 14 and 17)

- > Multiple operator access levels
- > Easy to use
- > Program (recipe) library
- > Extensive editing options including macro functions
- > Automatic optimisation tool for program creation
- > Data logging
- > Data export functions

Complies with all applicable legislation: CE, RoHS, 21CRF Part 11, MDD (option), ISO 13485

CRYOBIOLOGY

The IceCube™-Family

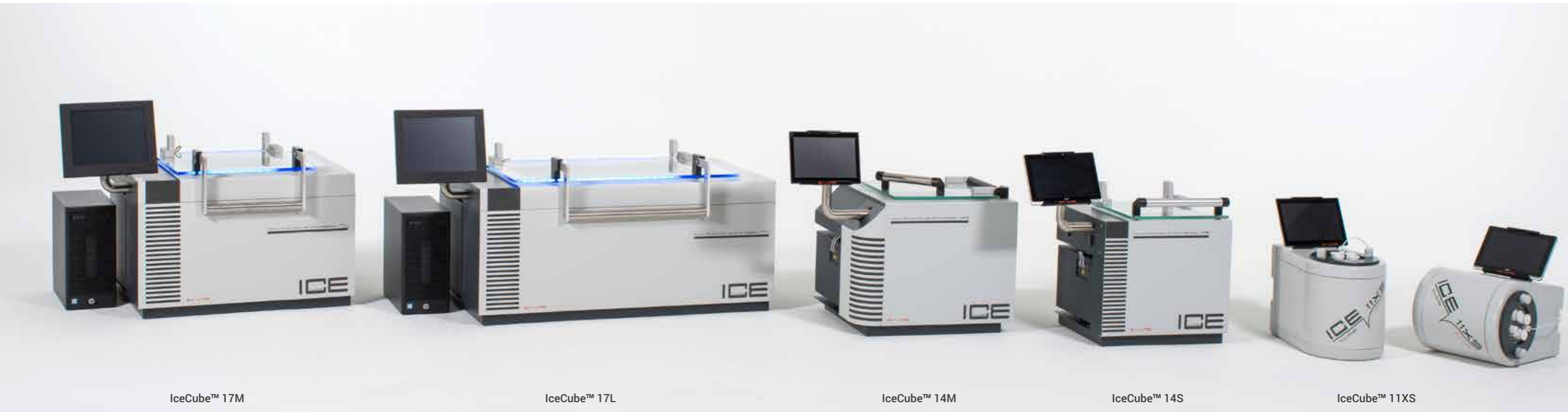

The IceCube series consists of five instruments with different capacities from 11XS to 17L. Its modern technology and flexibility provide the right solution for every application.

THE DEVICE CONCEPT

IceCube automatic freezing devices are equipped with innovative technology to achieve the highest sample viability.

Liquid nitrogen flows via a metal hose connection, as a gas, into the freezing chamber. Predetermined cooling profiles are used to freeze samples prior to removal and storage at cryogenic temperatures. Data logging ensures continual monitoring of the entire process, including multiple temperature sensor set-points, actual values and the supply pressure of liquid nitrogen.

OPTIONS

Depending on the quantity/size of samples, there are 5 instruments available, the 11XS to the 17L. For operation a separate liquid nitrogen supply dewar (liquid cylinder) is required. IceCube devices are operated via a computer, either a PC or a tablet.

For clinical applications, devices are certified to the Medical Device Directive (MDD). A wide variety of chamber furniture is available for freezing vials, straws, bags etc. including AutoSeeding racks.

CRYOSUPERIOR

The IceCube™-Series 17



IceCube™ 17M

IceCube™ 17L

THE SUPERIOR-TECHNOLOGY

PARALLEL FLOW – 17 Series units have the largest chamber volumes of the IceCube Range. Here the air/gas exchange is carried out in a large-scale circulating motion and the return takes place in the isolated outer area of the chambers.

Tightly controlled injectors meter the LIN⁹ addition according to the temperature difference between the set-point and the actual reading.

The large-scale Series 17 achieves parallel and cross-sectional replacement of gas volume across the whole chamber to give a uniform temperature profile. The gas flow in the instrument has been engineered to ensure a homogeneous temperature distribution throughout the chamber.

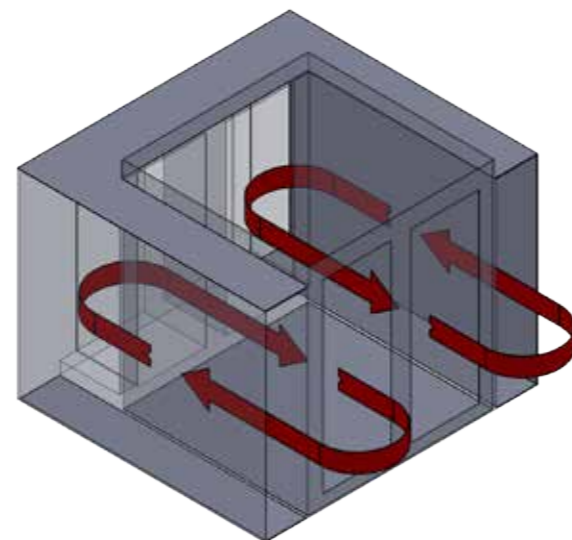

⁹ LIN Liquid Nitrogen

The NEW IceCube 17 Series combines the advanced technology of the proven data processing with an expansion of the chamber volume with two NEW larger models. Our renowned compact design and glass cover remain a distinctive feature of the IceCube 17 Series.



CRYOCLASSIC

The IceCube™-Series 11 and 14

The benefits of the IceCube Series

- > Versatile software suitable for both routine tasks and complex experiments
- > Reliable, robust freezers with internal and external computer
- > High resolution graphical interface, easy zoom and editing features with optimization of the freezing profile by automatic detection of the latent heat (Series 14 & 17)
- > Small footprint
- > Transparent chamber closure
- > Complies with all applicable legislation: CE, RoHS, 21CRF Part 11, MDD (option), ISO 13485



THE CLASSICS

11XS – SMALL DEVICE, COMPUTER CONTROLLED

- > Horizontal or vertical operating position
- > With optional configuration to hold 16 or 40 tubes, or a rack for 2/5 ml vials
- > Chamber and sample temperature sensors
- > Circulating cooling

SERIES 14 – COMPACT FREEZERS FOR RESEARCH AND THE CLINIC

- > Large safety glass door
- > Turbulent gas flow
- > Numerous optional accessories: including
 - 4 temperature sensors
 - automatic seeding device
 - supply pressure recording
 - remote alarms

CRYOCONSERVATION

The IceCube Chamber Technology

The required number of samples and their size defines the choice of the freezing chamber and hence the model. The sample itself can be filled into:

- > Sample tubes (straws, high security straws ...)
- > Vials, cryogenic vial boxes
- > Data Matrix Sample Tube Racks
- > Bloodbags (container ...) loose or in metal cassettes
- > Others, special racks on demand

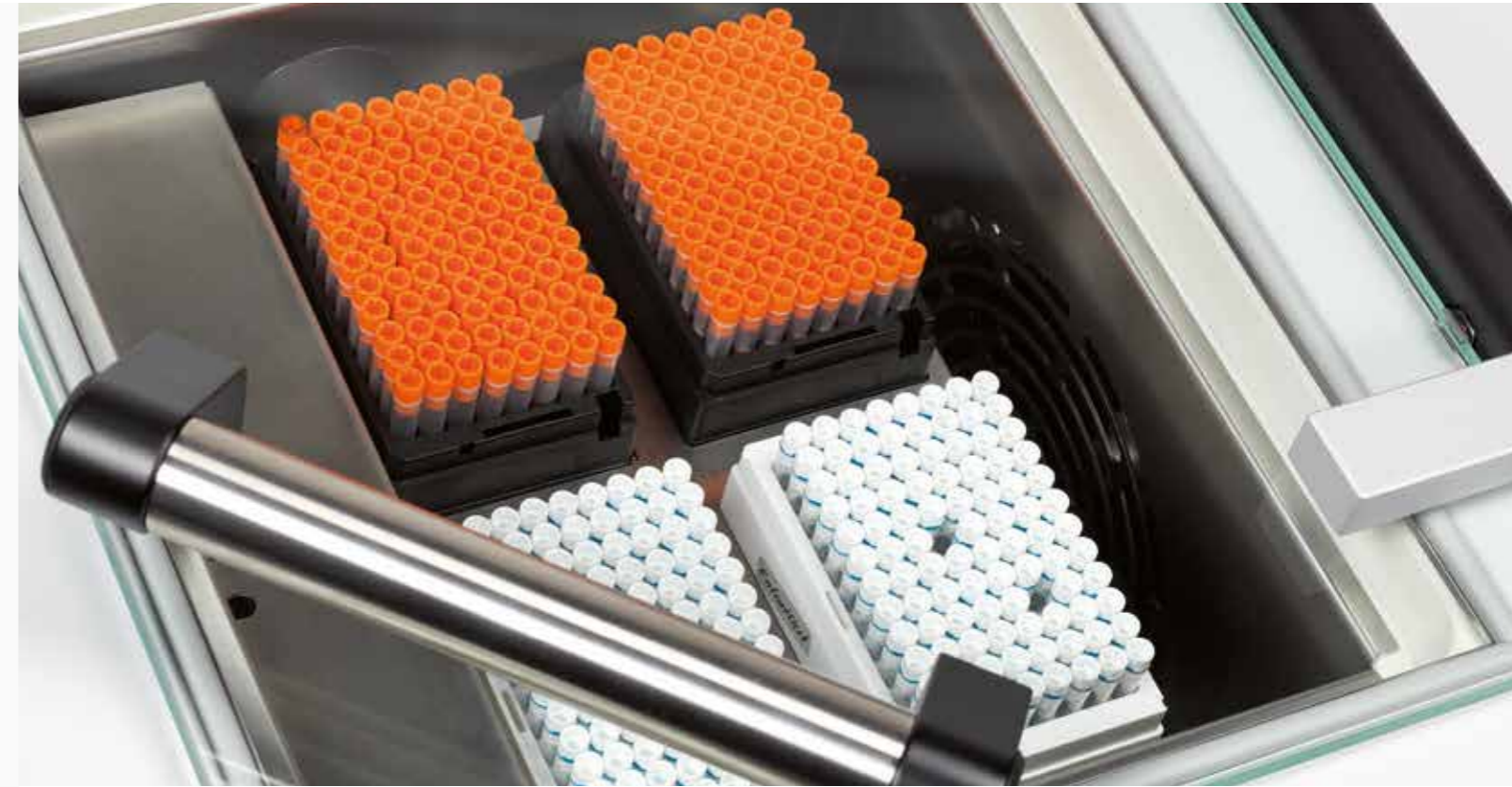

CHAMBER TECHNOLOGY

All freezing chambers are manufactured from stainless steel and the full-surface safety glass door is equipped with a protection mechanism to stop operation when opened.

The 11XS, our smallest controlled rate freezer, has recirculation cooling in a double-walled cylinder. The IceCube 14 and 17 models offer a range of options and a large number of holders and racks.

For the controlled rate freezing of Data Matrix Cryo Racks in SBS format, a forced-flow device is available in larger models.

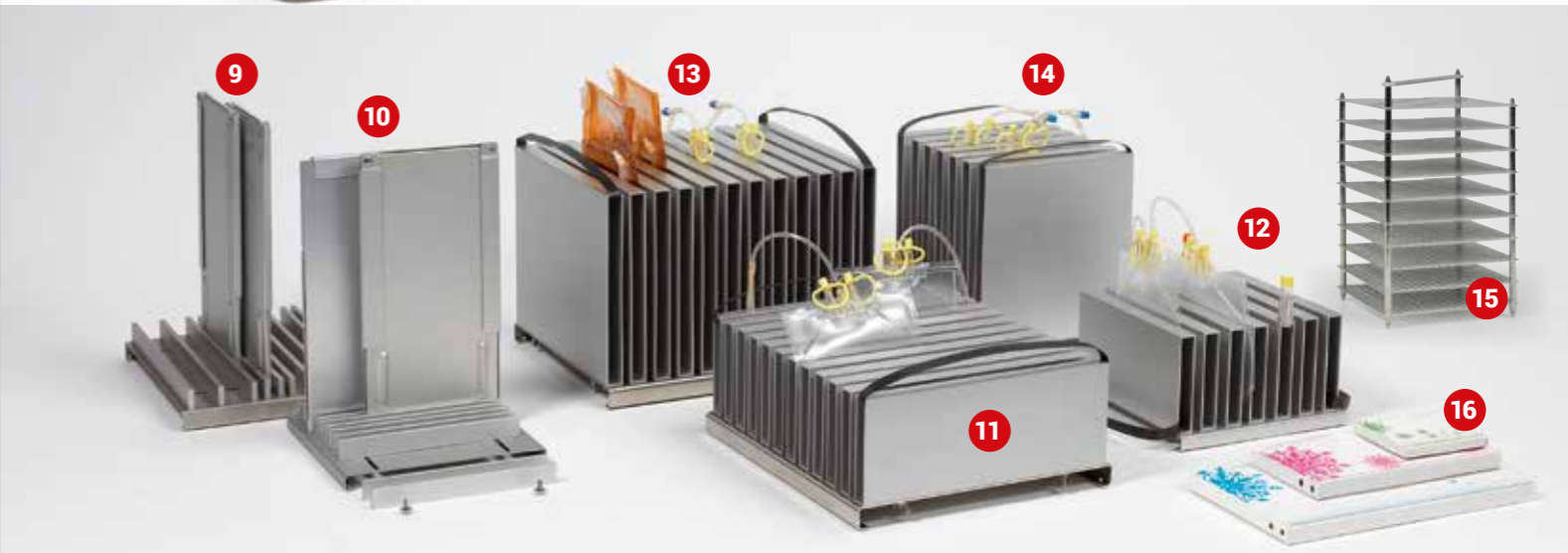
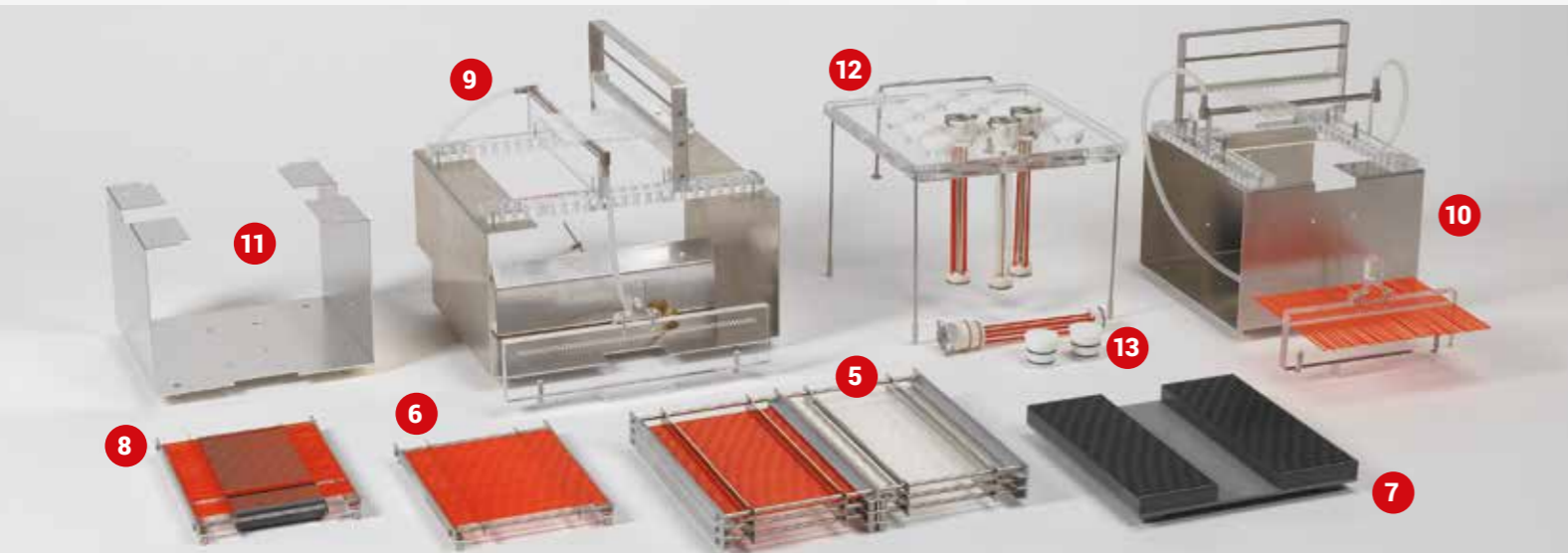
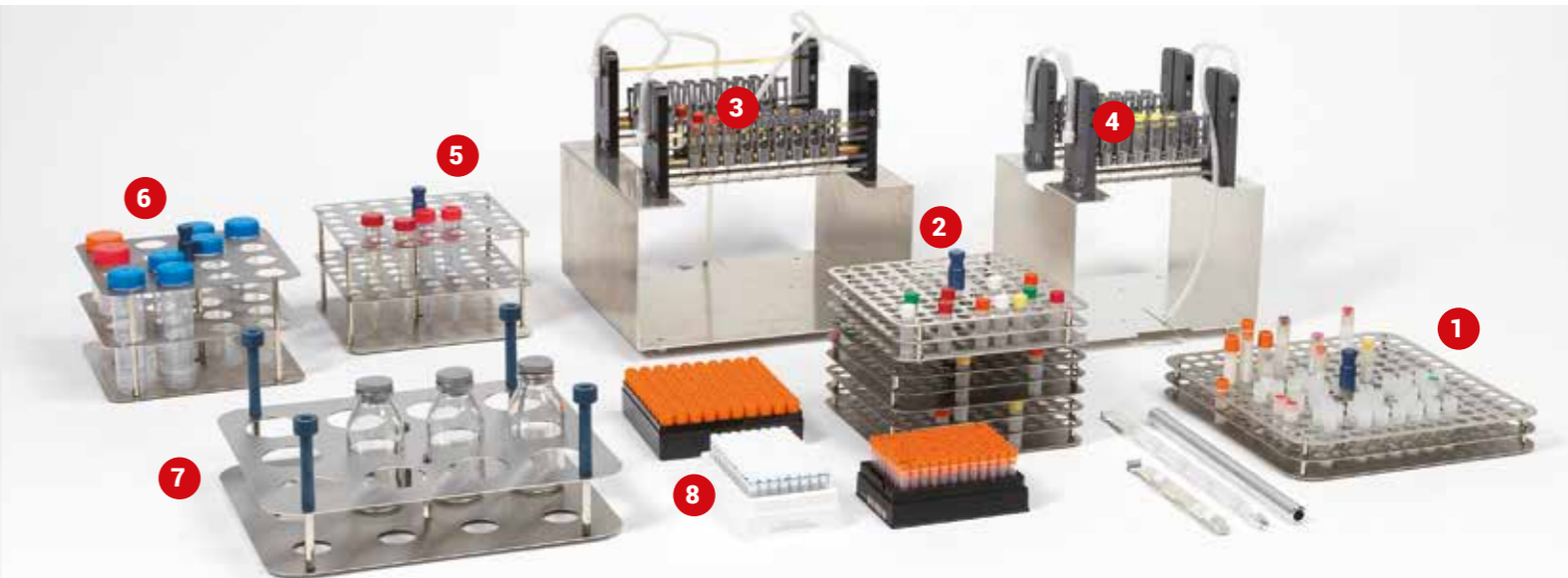

Item	Model	Description, rack for	Capacity	Total in chamber
1	11	Vials 2/5ml		36/18
2	11	Holder for straws	4 or 10	16 or 40
3	11	Temperature sensor chamber		
4	11	Temperature sensor sample		
5+6	14/17	Straws	different sizes	1080 - 11000
7+8	14/17	Straws distribution block		
9+10	14/17	AutoSeeding vials	2 - 5ml	33 - 58
11	14/17	Support/spacer	included in 9+10	
12	14/17	Topplate manual seeding ^{*)}	16 - 31	64 - 220
13	14/17	Holder for straws	4 or 10	64 - 220

^{*)} Support frame not included

Item	Model	Description, rack for	Capacity	Total in chamber
1+2	14/17	Vials 2/5ml	96 - 188	288 - 1128
3+4	14/17	AutoSeeding vials 2/5ml	26 - 38	several possible
5+6+7	14/17	Bottles various sizes	please advise specification	
8	14/17	Data Matrix Sample Tube Racks Vial Boxes	please specify	2 to max. 20
9+10	14/17	Bloodbags in metal cassettes		11 - 32
11 - 14	14/17	Bloodbags without envelopes, vertical		11 - 22
15	14/17	Bloodbags without envelopes, horizontal		10
16	14/17	Carton cassettes for bags	Datasheet available	

Images can vary in technical design or size. All specifications are from - to values and depend on the freezer model and the sample containers. We are pleased to give you exact values according to your application!



	11XS	14S	14M
Model	All models with tablet computer, MDD optional	Optional with tablet computer or PC with touch monitor MDD certification available	
Temperature range	+40°C to -150°C 104°F to -238°F	+40°C to -180°C (104°F to -292°F)	
Cooling rates	0.01 to 40°C/min	0.01 to 60°C/min	
Heating rates	0.01 to 10°C/min	0.01 to max. 15°C/min	
Temperature sensors in 4-wire-technique	Pt-100, 1.5 mm Ø x 65 mm length	Pt-100, 1.5 mm Ø x 65 mm length, or (option) 1 and 1.5 mm x 65/100/160/200 mm or temperature sensor flat (foil sensor)	
Temp. display resolution	0.01°C		
Freezing chamber size and capacity			
Chamber size (mm) (inch)	125 Ø x 132 (h) 4.92 Ø x 5.2	217 x 217 x 348 (h) 8.54 x 8.54 x 13.7	297 x 317 x 378 (h) 11.69 x 12.48 x 14.9
Volume (liter)	1.6	16	35
Straws 0.25 ml or 0.5 ml	max 40 either type	1650 1080	4140 2760
Vials 1.8 – 2 ml	36	480 in 5 racks	1128 in 6 racks
Vials 5 ml	18	288 in 3 racks	564 in 3 racks
Boxes and SBS format	–	Available in all models, information on request!	
Blood bags *)	–	6	11
Blood bags in metal cassettes *)	–	11	16
Outer dimensions W x D x H mm (lid open) inch (lid open)	300 x 480 x 520 11.8 x 18.9 x 20.4	540 x 420 x 520 (820) 21.3 x 17 x 20.5 (33)	630 x 510 x 550 (860) 25 x 20.1 x 21.7 (34)
Supply container, liquid cylinder	LIN supply container with automatic pressure built-up from 0.5 to max. 1.5 bar, recommended fill volume 60 - 240 l. All freezer models are equipped with a pressure relief valve.		
Pressure sensor (option)	–	Supply pressure monitor recording in real time	
AutoSeeding preparation (option)	–	Second LIN manifold with magnetic valve for automatic supply of a seeding rack for vials or straws	
Net weight without PC and accessories	~ 16.5	~29	~ 39
Electric supply, please specify at order	230/115 VAC 1.8/3.6 A	230/115 VAC 3.6/7.2 A	230/115 VAC 4.7/9.4 A
Options and accessories may differ among various freezer models.	A large selection of chamber furniture is available, 3.+4. temperature sensors, temperature sensor flat foil, potential-free alarm outputs, IQ/OQ protocols, uninterruptible power supply (UPS), insulated LIN metal hoses, LIN supply vessels, LIN storage solutions for processed samples, shipping containers, protective wear/face shields, aprons, gloves. Medical Product registration: requires technical monitoring and periodic inspection.		

17M	17L
Optional with tablet computer or PC with touch monitor MDD certification available	
+40°C to -180°C (104°F to -292°F)	
0.01 to -35°C/min	0.01 to -30°C/min
0.01 to max. 7°C/min	0.01 to max. 5°C/min
Pt-100, 1.5 mm Ø x 65 mm length, or (option) 1 and 1.5 mm x 65/100/160/200 mm or temperature sensor flat (foil sensor)	
0.01°C	
Freezing chamber size and capacity	
330 x 340 x 390 (h) 13 x 13.39 x 15.35	660 x 340 x 390 (h) 25.9 x 13.4 x 15.35
44	88
5520 3720	11040 7440
1128 in 6 racks	2256 in 12 racks
564 in 3 racks	1128 in 6 racks
Available in all models, information on request!	
11	22
16	32
750 x 660 x 560 (1010) 29.6 x 26 x 22.1 (39.8)	1090 x 660 x 560 (1010) 43 x 26 x 22.1 (39.8)
1.5 bar 70 - ≥240 l	
Supply pressure monitor recording in real time	
Second LIN manifold with magnetic valve for automatic supply of a seeding rack for vials or straws	
~ 68	~ 85
230/115 VAC 5.5/11 A	230/115 VAC 5.5/11 A
A large selection of chamber furniture is available, 3.+4. temperature sensors, temperature sensor flat foil, potential-free alarm outputs, IQ/OQ protocols, uninterruptible power supply (UPS), insulated LIN metal hoses, LIN supply vessels, LIN storage solutions for processed samples, shipping containers, protective wear/face shields, aprons, gloves. Medical Product registration: requires technical monitoring and periodic inspection.	

*) Depending on size and/or filling volume

Specifications are subject to change without notice.

SY-LAB

LIFE FROM COLD

Distributor:

Version 1.0.gb

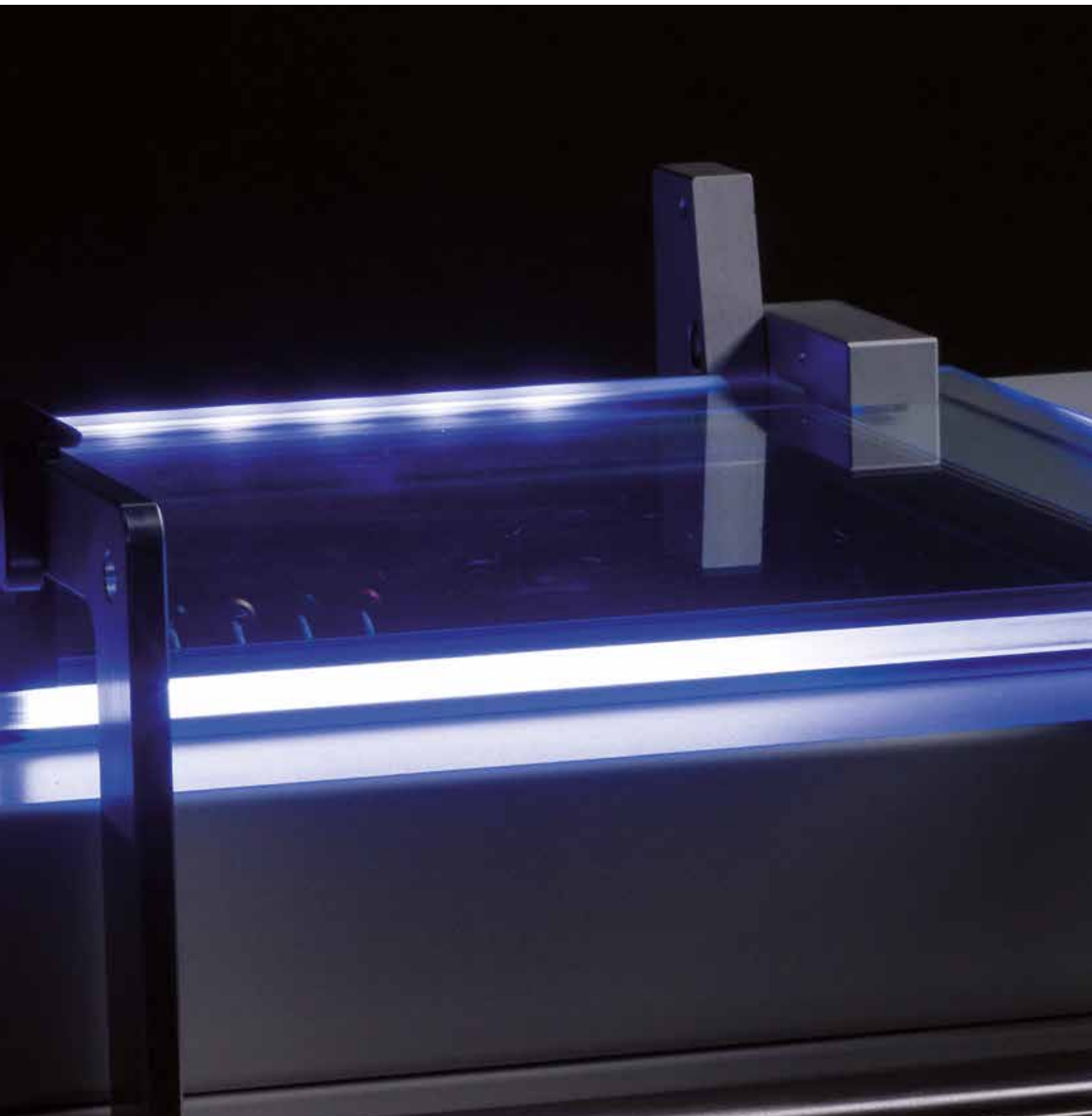

000 «Диаэм»

Москва
ул. Магаданская, д. 7, к. 3 ■ тел./факс: (495) 745-0508 ■ sales@dia-m.ru

www.dia-m.ru

С.-Петербург
+7 (812) 372-6040
spb@dia-m.ru

Новосибирск
+7(383) 328-0048
nsk@dia-m.ru

Воронеж
+7 (473) 232-4412
vrn@dia-m.ru

Йошкар-Ола
+7 (927) 880-3676
nba@dia-m.ru

Красноярск
+7(923) 303-0152
krsk@dia-m.ru

Казань
+7(843) 210-2080
kazan@dia-m.ru

Ростов-на-Дону
+7 (863) 303-5500
rnd@dia-m.ru

Екатеринбург
+7 (912) 658-7606
ekb@dia-m.ru

Кемерово
+7 (923) 158-6753
kemerovo@dia-m.ru

Армения
+7 (094) 01-0173
armenia@dia-m.ru

