

Glass Oven B-585

Technical data sheet

With the unique electrically conductive glass tube coating, the Glass Oven B-585 offers visibility of your sample at any time. The whole length of the oven tube heats up to a maximum of 300 °C. Signs of thermal degradation are easily visible as the process can be seen at any time. The oven is equipped with a graphic display capable of manual and programmable modes. It features programmable 3 step temperature / time control setting options.

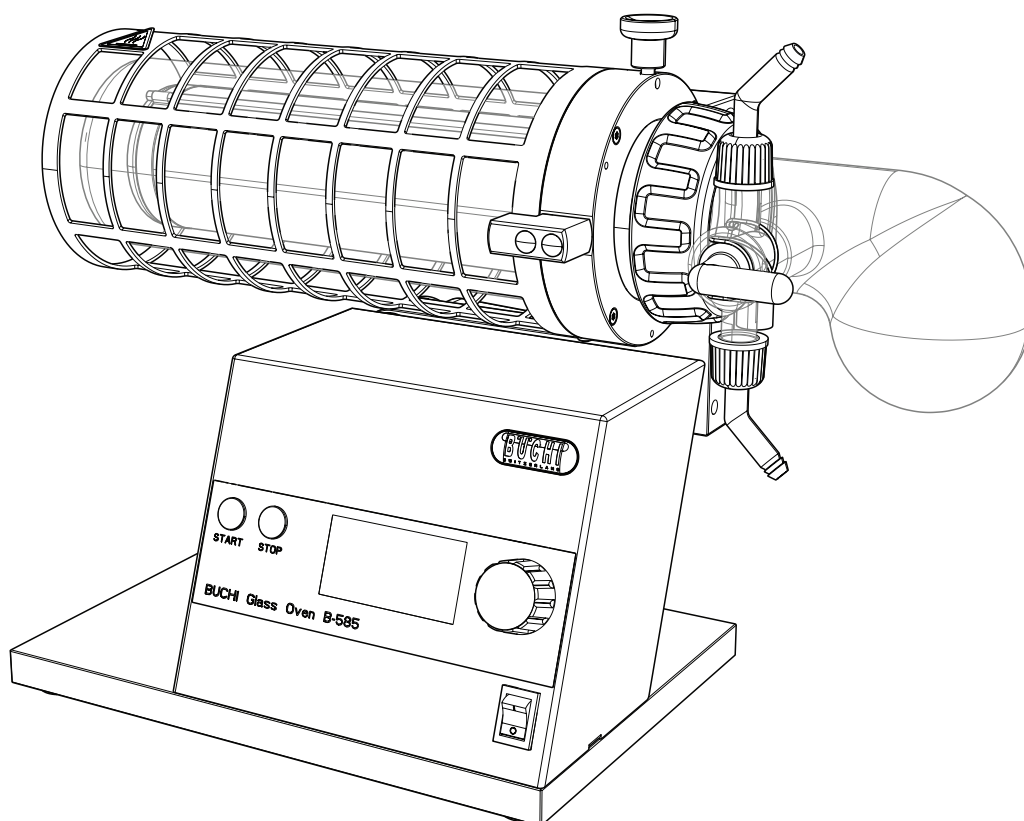

Overview

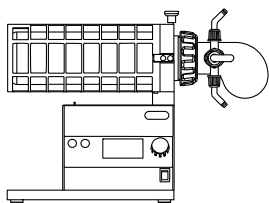

Glass Oven B-585 Drying

The Glass Oven B-585 Drying is suited for the removal of residual solvents at high temperatures. The process can be further accelerated by optionally applying vacuum. An adjustable angle of up to 90 ° allows for larger sample volumes.

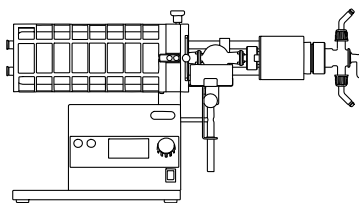

Glass Oven B-585 Kugelrohr

The Glass Oven B-585 Kugelrohr is suited for the fractionated distillation of small amounts of solvents. Optional accessories allow for further applications such as sublimation or freeze drying.

Scope of delivery

The Glass Oven B-585 is available in two different versions, either as “Drying” or “Kugelrohr”.

Components

B-585

Glass Oven B-585 main unit	1
Drying option or Kugelrohr option (depends on the ordered version)	1
Power cord	1
Operation manual	1

Order code

Choose the configuration according to your needs:

0 4 6 6 0 0

Glass Oven B-585 Drying (100 – 230 V)

0 4 6 7 2 0

Glass Oven B-585 Drying (100 V)

0 4 6 6 0 1

Glass Oven B-585 Kugelrohr (100 – 230 V)

0 4 6 7 2 1

Glass Oven B-585 Kugelrohr (100 V)

Technical data

Glass oven

Specification	B-585 Drying	B-585 Kugelrohr
Dimensions (W x D x H)	410 x 300 x 300 mm	650 x 300 x 300 mm
Weight	9.5 kg	11.5 kg
Drying volume	100 – 250 mL	5 – 40 mL
Adjustable angle	0 – 90 °	–
Rotation speed	–	0 – 50 rpm
Connection voltage	100 V – 230 V ± 15 %	100 V – 230 V ± 15 %
Frequency	50 / 60 Hz	50 / 60 Hz
Power consumption	max. 450 W	max. 450 W
Warm-up time (from 20 to 300 °C)	approx. 10 min.	approx. 10 min.
Temperature regulation range	40 – 300 °C	40 – 300 °C
Temperature precision (in center of the oven at 300 °C)	± 5 °C	± 5 °C
Temperature display	steps of 1 °C	steps of 1 °C
Programmable gradient steps	3	3
Available languages of the program	en, es, de, it, fr, ja	en, es, de, it, fr, ja
Vacuum pump connection (ON/OFF)	Yes	Yes
Approvals	CE / CSA	CE / CSA

Exemplary solution



The following items are listed based on the solution «Glass Oven All in One».

	Order no.
Interface I-100, Vacuum Pump V-100 incl. Woulff bottle	11V100110

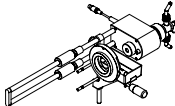
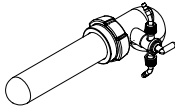
Accessories

	Order no.	Image
Kugelrohr conversion kit. Incl. cooling unit, suction angle, drive Complete ball tube drive for converting to a ball tube distillation oven (Kugelrohr) incl. cooling device.	046617	
Drying accessory. Glass, incl. stopcock, flange ring, O-ring For converting to the drying model. For sample volumes of 100 to 250 mL.	037010	

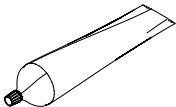
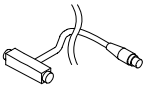
	Order no.	Image
Freeze drying accessory. Glass, incl. glass tube, screw cap, O-ring For freeze drying applications. Meant to be used with the drying accessory and either a condenser or cold trap.	046710	
Sublimation accessory. Glass, incl. stopcock, flange ring, O-ring For conversion to the sublimation configuration.	037133	
Rotation drying flask. Glass, 30 mL, SJ14/23 Content: Drying flask, vapor duct, clip	037143	
Ball tube. Glass, 10 mL (4 pcs), SJ14/23 Content: Ball tubes, Vapor duct, clips	037118	
Ball tube. Glass, 20 mL (3 pcs), SJ14/23 Content: Ball tubes, Vapor duct, clips	037107	
Ball tube. Glass, 40 mL (2 pcs), SJ14/23 Content: Ball tubes, Vapor duct, clips	037117	
Condenser V. Vertical condenser, 1500 cm ² For distillations and freeze drying application. Used with recirculating chiller or tap water. Content: 250 mL receiving flask, ball joint clamp, vacuum connection (P+G).	046711	
Condenser C. Cold trap, 500 cm ² For freeze drying application and for distillations of low-boiling point solvents. Content: 250 mL receiving flask, ball joint clamp, vacuum connection (P+G).	046712	
Cooling unit. Incl. cooling device For substances with a low boiling point, to condense the vapor in the balls outside of the oven area. Cooling device can be filled with e.g. ice-water or dry ice.	046616	

	Order no.	Image
Lab grease. Glisseal 40 (60 g) To grease joints in order to increase tightness of system.	048197	
Communication cable. Mini-DIN, 1.5 m Connection between glass oven and vacuum pump.	038010	
IQ/OQ. B-585 en	11057340	
OQ. B-585 en	11057341	

Ware parts

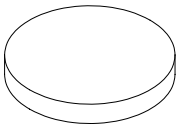
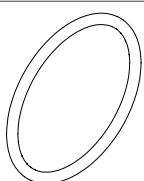
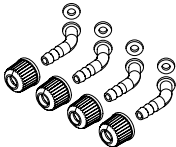
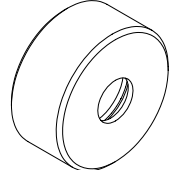
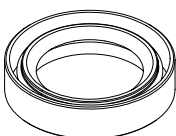
	Order no.	Image
Sealing disc. EPDM, Ø36 mm, for closing cap (038691)	038679	
O-ring. NBR, Ø 50.4 mm	002797	
Hose barbs, set. 4 pcs, bent GL14, silicone seal Content: Hose barbs, cap nuts, seals	037287	
Cap nut. Ø 20/35 mm, black For ball tube drive (037013).	036824	
Vacuum gasket. Shaft seal ring, FKM, Ø 22/35 mm	000622	

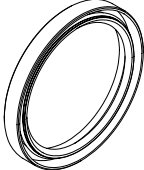
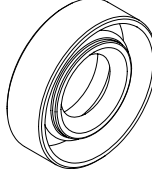
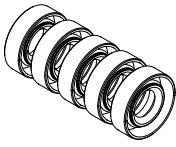
	Order no.	Image
Vacuum gasket. Shaft seal ring, NBR, Ø 70/90 mm	001223	
Vacuum gasket. Shaft seal ring, NBR, Ø 10/24 mm	002862	
Vacuum gaskets, set. 5 pcs, shaft seal ring, FKM, Ø 10/24 mm	037288	

Tubing

	Order no.
Tubing. Silicone, Ø6/9 mm, transparent, per m Use: Cooling media.	004133

000 «Диаэм»

Москва
ул. Магаданская, д. 7, к. 3 ■ тел./факс: (495) 745-0508 ■ sales@dia-m.ru

www.dia-m.ru

С.-Петербург
+7 (812) 372-6040
spb@dia-m.ru

Новосибирск
+7 (383) 328-0048
nsk@dia-m.ru

Воронеж
+7 (473) 232-4412
vrn@dia-m.ru

Йошкар-Ола
+7 (927) 880-3676
nba@dia-m.ru

Красноярск
+7 (923) 303-0152
krsk@dia-m.ru

Казань
+7 (843) 210-2080
kazan@dia-m.ru

Ростов-на-Дону
+7 (863) 303-5500
rnd@dia-m.ru

Екатеринбург
+7 (912) 658-7606
ekb@dia-m.ru

Кемерово
+7 (923) 158-6753
kemerovo@dia-m.ru

Армения
+7 (094) 01-0173
armenia@dia-m.ru

