



Gas cylinder cabinet G-ULTIMATE-90
Model G90.205.090, light grey (RAL 7035)

Safe and approved storage of flammable or toxic gases in working areas – for up to 3 x 50-litre gas cylinders

Function / construction:

- **No unauthorised use:** doors lockable with profile cylinder (integration in an existing locking system possible)
- **Easy alignment:** adjusting aids to compensate for uneven floor
- **Easy mounting of connecting pipes and gas fittings:** large interior height (1890 mm), many lead-through possibilities on the top of the cabinet
- **Ventilation:** integrated air ducts ready for connection (DN 75) to a technical exhaust, even ventilation inside the cabinet
- **Tested and certified:** according to the stricter GS principles

Available equipment:

- Cylinder retainer – variable installation in the cabinet, flexibly adjustable in depth, across the entire width of the cabinet
- Comfort interior equipment – complete with mounting rails, rolling ramp (L = 350 mm) with pneumatic damper, cylinder retainer and matching tension belts
- Standard interior equipment – complete with mounting rails, rolling ramp and cylinder retainer
- Lateral cylinder retainer – for two 10-litre cylinders, alternatively in height adjustable version (no tools required)

Dimensions

Width (external)	898.00 mm
Depth (external)	615.00 mm
Height (external)	2050.00 mm
Width (internal)	745.00 mm
Depth (internal)	425.00 mm
Height (internal)	1858.00 mm

The available internal dimensions can vary depending on the interior equipment package.

Weight / Load

Weight without interior equipment	490 kg
Distributed load	752.00 kg/m ²
Maximum load	600 kg

Ventilation

Extraction air	75 DN
Minimum exhaust air quantity 10 times	6 m ³ /h
Minimum exhaust air quantity 120 times	66 m ³ /h

For further details of the lead-through possibilities and exhaust air please have a closer look to EN 14470-2.

Colouring / Surface finish

Body colour code	RAL 7035
Body colour	Light grey
Body surface finish	plain
Door / Drawer colour code	RAL 7035
Door / Drawer colour	Light grey
Door / Drawer surface finish	plain

General Information

Number of doors	2
Door opening angle	180.00°
Depth with open doors	1090 mm
x 50-litre gas cylinders	3 piece
Customs tariff number	94032080



Front view

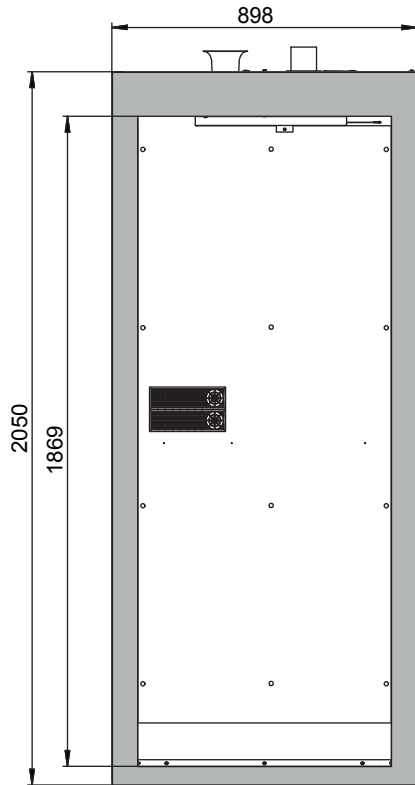

Side view

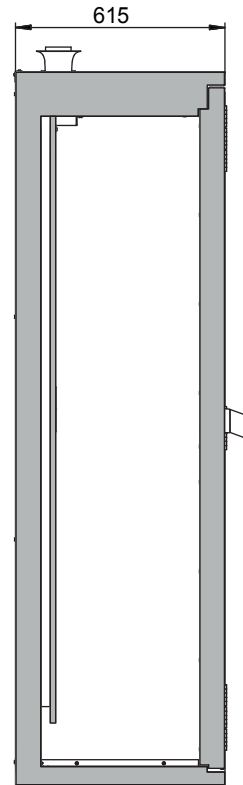

Top view

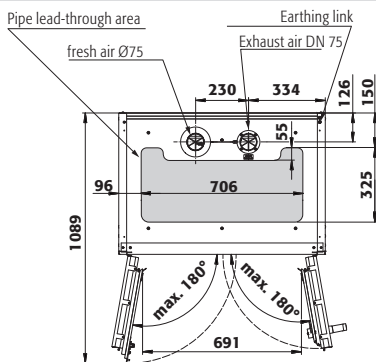

000 «Диаэм»

Москва

ул. Магаданская, д. 7, к. 3 ■ тел./факс: (495) 745-0508 ■ sales@dia-m.ru

www.dia-m.ru

С.-Петербург
+7 (812) 372-6040
spb@dia-m.ru

Новосибирск
+7 (383) 328-0048
nsk@dia-m.ru

Воронеж
+7 (473) 232-4412
vrn@dia-m.ru

Йошкар-Ола
+7 (927) 880-3676
nba@dia-m.ru

Красноярск
+7 (923) 303-0152
krsk@dia-m.ru

Казань
+7 (843) 210-2080
kazan@dia-m.ru

Ростов-на-Дону
+7 (863) 303-5500
rnd@dia-m.ru

Екатеринбург
+7 (912) 658-7606
ekb@dia-m.ru

Кемерово
+7 (923) 158-6753
kemerovo@dia-m.ru

Армения
+7 (094) 01-0173
armenia@dia-m.ru

